

Leica RTC360



User Manual
Version 1.0
English

- when it has to be **right**

Leica
Geosystems

Introduction

Purchase

Congratulations on the purchase of a Leica RTC360 series instrument.



This manual contains important safety directions as well as instructions for setting up the product and operating it. Refer to "1 Safety Directions" for further information.

Read carefully through the User Manual before you switch on the product.

To ensure safety when using accompanying battery charger, also observe the directions and instructions contained in the User Manual of the battery charger.

Product identification

The model and serial number of your product are indicated on the type plate.

Always refer to this information when you need to contact your agency or Leica Geosystems authorised service centre.

Trademarks



- Windows is a registered trademark of Microsoft Corporation in the United States and other countries

All other trademarks are the property of their respective owners.

Leica Geosystems address book

On the last page of this manual, you can find the address of Leica Geosystems headquarters. For a list of regional contacts, please visit http://leica-geosystems.com/contact-us/sales_support.

Available documentation

Name	Description/Format		
Leica RTC360 Quick Guide	Provides an overview of the product together with technical data and safety directions. Intended as a quick reference guide.	✓	✓
Leica RTC360 User Manual	All instructions required in order to operate the product to a basic level are contained in the User Manual. Provides an overview of the product together with technical data and safety directions.	-	✓
Leica RTC360 tutorial videos	How-to videos explaining the basic workflow. https://www.youtube.com/playlist?list=PL0td7rOVk_IWwYh5GDTKjP--nTu3n0WzK	-	-

Refer to the following resources for all RTC360 documentation/software:

- the supplied USB documentation card
- <https://myworld.leica-geosystems.com>

Table of Contents

1	Safety Directions	5
1.1	General Introduction	5
1.2	Definition of Use	5
1.3	Limits of Use	6
1.4	Responsibilities	6
1.5	Hazards of Use	7
1.6	Laser Classification	10
	1.6.1 General	10
	1.6.2 Scanning Laser	11
1.7	Electromagnetic Compatibility EMC	11
1.8	FCC Statement, Applicable in U.S.	13
1.9	ICES-003 Statement, Applicable in Canada	15
2	Description of the System	16
2.1	Packing / Unpacking the Instrument	16
2.2	Container Contents	16
2.3	Backpack Contents	17
2.4	Instrument Components	17
2.5	System Components	18
2.6	System Concept	18
	2.6.1 Power Concept	18
	2.6.2 Data Storage Concept	18
3	User Interface	20
3.1	Power Button	20
3.2	Device Status	20
3.3	Screen	22
4	Operation	23
4.1	Instrument Setup	23
	4.1.1 General Information	23
	4.1.2 Lightweight Tripod Setup	23
	4.1.3 Heavy Duty Tripod Setup	24
4.2	Power Supply	24
	4.2.1 Batteries	24
	4.2.2 Exchanging the Batteries	25
4.3	Operation - Getting Started	26
4.4	Imaging	27
4.5	Scanning	28
	4.5.1 Ambient Conditions	28
	4.5.2 Onboard Controls	28
	4.5.3 Troubleshooting	30
	4.5.4 Field of View (FoV)	31
4.6	Data Transfer	31
4.7	Working with the USB Data Storage Device	31
5	Care and Transport	33
5.1	Transport	33
5.2	Field Check	33
5.3	Storage	33
5.4	Cleaning and Drying	34
5.5	Glass Cleaning Procedure	34
6	Technical Data	36
6.1	General Technical Data of the Product	36
6.2	System Performance	36

6.3	Laser System Performance	37
6.4	Electrical Data	38
6.4.1	Pin Assignment of Lemo Ports	39
6.5	Environmental Specifications	40
6.5.1	RTC360	40
6.5.2	GEB361 Battery and GEV282 AC/DC Power Supply	40
6.6	Dimensions	41
6.7	Weight	42
6.8	Accessories	43
6.9	Conformity to National Regulations	43
6.9.1	RTC360	43
6.9.2	Dangerous Goods Regulations	44
7	Software Licence Agreement	45

1 Safety Directions

1.1 General Introduction

Description

The following directions enable the person responsible for the product, and the person who actually uses the equipment, to anticipate and avoid operational hazards.

The person responsible for the product must ensure that all users understand these directions and adhere to them.

About warning messages





Warning messages are an essential part of the safety concept of the instrument. They appear wherever hazards or hazardous situations can occur.

Warning messages...

- make the user alert about direct and indirect hazards concerning the use of the product.
- contain general rules of behaviour.

For the users' safety, all safety instructions and safety messages shall be strictly observed and followed! Therefore, the manual must always be available to all persons performing any tasks described here.

DANGER, WARNING, CAUTION and **NOTICE** are standardised signal words for identifying levels of hazards and risks related to personal injury and property damage. For your safety, it is important to read and fully understand the following table with the different signal words and their definitions! Supplementary safety information symbols may be placed within a warning message as well as supplementary text.

Type	Description
 DANGER	Indicates an imminently hazardous situation which, if not avoided, will result in death or serious injury.
 WARNING	Indicates a potentially hazardous situation or an unintended use which, if not avoided, could result in death or serious injury.
 CAUTION	Indicates a potentially hazardous situation or an unintended use which, if not avoided, may result in minor or moderate injury.
NOTICE	Indicates a potentially hazardous situation or an unintended use which, if not avoided, may result in appreciable material, financial and environmental damage.
	Important paragraphs which must be adhered to in practice as they enable the product to be used in a technically correct and efficient manner.

1.2 Definition of Use

Intended use

- Measuring horizontal and vertical angles.
- Measuring distances.
- Scanning objects.
- Capturing and recording images.
- Recording measurements.

- Computing with software.
- Remote control of product.
- Data communication with external appliances.

Reasonably foreseeable misuse

- Use of the product without instruction.
- Use outside of the intended use and limits.
- Disabling safety systems.
- Removal of hazard notices.
- Opening the product using tools, for example screwdriver, unless this is permitted for certain functions.
- Modification or conversion of the product.
- Use after misappropriation.
- Use of products with recognisable damages or defects.
- Use with accessories from other manufacturers without the prior explicit approval of Leica Geosystems.
- Inadequate safeguards at the working site.
- Deliberate dazzling of third parties.

1.3

Limits of Use

Environment

Suitable for use in an atmosphere appropriate for permanent human habitation: not suitable for use in aggressive or explosive environments.

WARNING

Working in hazardous areas, or close to electrical installations or similar situations.

Life Risk.

Precautions:

- ▶ Local safety authorities and safety experts must be contacted by the person responsible for the product before working in such conditions.



The following advice is only valid for AC adapters and chargers.

Environment

Suitable for use in dry environments only and not under adverse conditions.



1.4

Responsibilities

Manufacturer of the product

Leica Geosystems AG, CH-9435 Heerbrugg, hereinafter referred to as Leica Geosystems, is responsible for supplying the product, including the User Manual and original accessories, in a safe condition.

Person responsible for the product

The person responsible for the product has the following duties:

- To understand the safety instructions on the product and the instructions in the User Manual.
- To ensure that it is used in accordance with the instructions.
- To be familiar with local regulations relating to safety and accident prevention.
- To inform Leica Geosystems immediately if the product and the application becomes unsafe.
- To ensure that the national laws, regulations and conditions for the operation of the product are respected.

1.5

Hazards of Use

WARNING

Distraction or loss of attention

During dynamic applications there is a danger of accidents occurring if the user does not pay attention to the environmental conditions around, for example obstacles, excavations or traffic.

Precautions:

- ▶ The person responsible for the product must make all users fully aware of the existing dangers.

WARNING

Inadequate securing of the working site.

This can lead to dangerous situations, for example in traffic, on building sites and at industrial installations.

Precautions:

- ▶ Always ensure that the working site is adequately secured.
- ▶ Adhere to the regulations governing safety, accident prevention and road traffic.

NOTICE

Dropping, misusing, modifying, storing the product for long periods or transporting the product

Watch out for erroneous measurement results.

Precautions:

- ▶ Periodically carry out test measurements, particularly after the product has been subjected to abnormal use and before and after important measurements.

CAUTION

Moving parts at the product during operation

Risk of squeezing extremities or entanglement of hair and/or clothes.

Precautions:

- ▶ Keep a safe distance to the moving parts.



If the instrument moves unexpectedly during operation, stop the instrument via user interface (display, key) or alternatively remove the battery or main power source to prevent further movements.

CAUTION

Not properly secured accessories.

If the accessories used with the product are not properly secured and the product is subjected to mechanical shock, for example blows or falling, the product may be damaged or people can sustain injury.

Precautions:

- ▶ When setting up the product, make sure that the accessories are correctly adapted, fitted, secured, and locked in position.
- ▶ Avoid subjecting the product to mechanical stress.

WARNING

Exposure of batteries to high mechanical stress, high ambient temperatures or immersion into fluids

This can cause leakage, fire or explosion of the batteries.

Precautions:

- ▶ Protect the batteries from mechanical influences and high ambient temperatures. Do not drop or immerse batteries into fluids.

WARNING

Short circuit of battery terminals

If battery terminals are short circuited e.g. by coming in contact with jewellery, keys, metallised paper or other metals, the battery can overheat and cause injury or fire, for example by storing or transporting in pockets.

Precautions:

- ▶ Make sure that the battery terminals do not come into contact with metallic objects.

WARNING

Inappropriate mechanical influences to batteries

During the transport, shipping or disposal of batteries it is possible for inappropriate mechanical influences to constitute a fire hazard.

Precautions:

- ▶ Before shipping the product or disposing it, discharge the batteries by the product until they are flat.
- ▶ When transporting or shipping batteries, the person in charge of the product must ensure that the applicable national and international rules and regulations are observed.
- ▶ Before transportation or shipping, contact your local passenger or freight transport company.

WARNING

If the product is improperly disposed of, the following can happen:

- If polymer parts are burnt, poisonous gases are produced which may impair health.
- If batteries are damaged or are heated strongly, they can explode and cause poisoning, burning, corrosion or environmental contamination.
- By disposing of the product irresponsibly you may enable unauthorised persons to use it in contravention of the regulations, exposing themselves and third parties to the risk of severe injury and rendering the environment liable to contamination.
- The product includes parts of Beryllium inside. Any modification of some internal parts can release dust or fragments, creating health hazard.

Precautions:

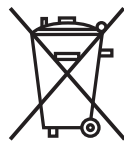

The product must not be disposed with household waste. Dispose of the product appropriately in accordance with the national regulations in force in your country. Always prevent access to the product by unauthorised personnel.

Product-specific treatment and waste management information can be received from your Leica Geosystems distributor.



Applies only for California. The product contains CR Lithium Cell(s) with perchlorate material inside – special handling may apply. See <http://www.dtsc.ca.gov/hazardouswaste/perchlorate/>

WARNING

Lightning strike

If the product is used with accessories, for example masts, staffs, poles, you may increase the risk of being struck by lightning.

Precautions:

- ▶ Do not use the product in a thunderstorm.

WARNING

Improperly repaired equipment

Risk of injuries to users and equipment destruction due to lack of repair knowledge.

Precautions:

- ▶ Only authorised Leica Geosystems Service Centres are entitled to repair these products.

For the AC/DC power supply and the battery charger:

WARNING

Unauthorised opening of the product

Either of the following actions may cause you to receive an electric shock:

- Touching live components
- Using the product after incorrect attempts were made to carry out repairs.

Precautions:

- ▶ Do not open the product!
- ▶ Only Leica Geosystems authorised service centres are entitled to repair these products.

For the AC/DC power supply and the battery charger:

WARNING

Electric shock due to use under wet and severe conditions

If unit becomes wet it may cause you to receive an electric shock.

Precautions:

- ▶ If the product becomes humid, it must not be used!
- ▶ Use the product only in dry environments, for example in buildings or vehicles.



- ▶ Protect the product against humidity.

WARNING

Electric shock due to missing ground connection

If unit is not connected to ground, death or serious injury can occur.

Precautions:

- ▶ The power cable and power outlet must be grounded!



1.6

Laser Classification

1.6.1

General

General

The following chapters provide instructions and training information about laser safety according to international standard IEC 60825-1 (2014-05) and technical report IEC TR 60825-14 (2004-02). The information enables the person responsible for the product and the person who actually uses the equipment, to anticipate and avoid operational hazards.

- ☞ According to IEC TR 60825-14 (2004-02), products classified as laser class 1, class 2 and class 3R do not require:
 - laser safety officer involvement,
 - protective clothes and eyewear,
 - special warning signs in the laser working area
 if used and operated as defined in this User Manual due to the low eye hazard level.
- ☞ National laws and local regulations could impose more stringent instructions for the safe use of lasers than IEC 60825-1 (2014-05) and IEC TR 60825-14 (2004-02).

1.6.2

Scanning Laser

General

The laser incorporated in the product produces an invisible beam, which emerges from the rotating mirror.

The laser product described in this section is classified as laser class 1 in accordance with:

- IEC 60825-1 (2014-05): "Safety of laser products"

These products are safe under reasonably foreseeable conditions of operation and are not harmful to the eyes provided that the products are used and maintained in accordance with this User Manual.

Description	Value
Wavelength	1550 nm
Maximum pulse energy	1.6 μ J
Pulse duration	0.5 ns
Maximum pulse repetition frequency (PRF)	2 MHz
Beam divergence (1/e ² , full angle)	0.5 mrad
Mirror rotation	100 Hz
Base rotation	10 mHz

Labelling

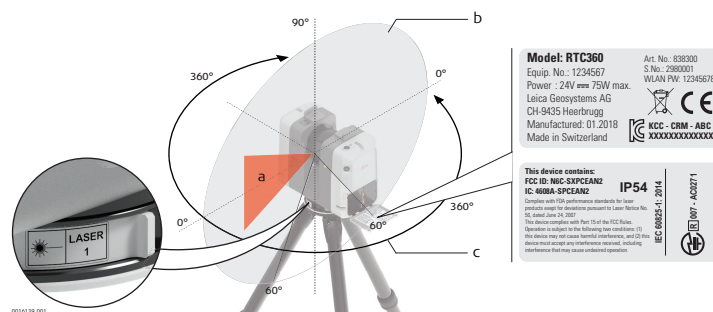

- a Laser beam
- b Vertical laser scanning area
- c Horizontal laser scanning area

Class 1 Laser
Product
according to IEC
60825-1
(2014-05)

1.7

Electromagnetic Compatibility EMC

Description

The term Electromagnetic Compatibility is taken to mean the capability of the product to function smoothly in an environment where electromagnetic radia-

tion and electrostatic discharges are present, and without causing electromagnetic disturbances to other equipment.

 **WARNING**

Electromagnetic radiation

Electromagnetic radiation can cause disturbances in other equipment.

Precautions:

- ▶ Although the product meets the strict regulations and standards which are in force in this respect, Leica Geosystems cannot completely exclude the possibility that other equipment may be disturbed.

 **CAUTION**

Use of the product with accessories from other manufacturers. For example field computers, personal computers or other electronic equipment, non-standard cables or external batteries

This may cause disturbances in other equipment.

Precautions:

- ▶ Use only the equipment and accessories recommended by Leica Geosystems.
- ▶ When combined with the product, they meet the strict requirements stipulated by the guidelines and standards.
- ▶ When using computers, two-way radios or other electronic equipment, pay attention to the information about electromagnetic compatibility provided by the manufacturer.

 **CAUTION**

Intense electromagnetic radiation. For example, near radio transmitters, transponders, two-way radios or diesel generators

Although the product meets the strict regulations and standards which are in force in this respect, Leica Geosystems cannot completely exclude the possibility that function of the product may be disturbed in such an electromagnetic environment.

Precautions:

- ▶ Check the plausibility of results obtained under these conditions.

 **CAUTION**

Electromagnetic radiation due to improper connection of cables

If the product is operated with connecting cables attached at only one of their two ends, for example external supply cables, interface cables, the permitted level of electromagnetic radiation may be exceeded and the correct functioning of other products may be impaired.

Precautions:

- ▶ While the product is in use, connecting cables, for example product to external battery, product to computer, must be connected at both ends.

⚠ WARNING

Use of product with radio or digital cellular phone devices

Electromagnetic fields can cause disturbances in other equipment, in installations, in medical devices, for example pacemakers or hearing aids and in aircraft. It can also affect humans and animals.

Precautions:

- ▶ Although the product meets the strict regulations and standards which are in force in this respect, Leica Geosystems cannot completely exclude the possibility that other equipment can be disturbed or that humans or animals can be affected.
- ▶ Do not operate the product with radio or digital cellular phone devices in the vicinity of filling stations or chemical installations, or in other areas where an explosion hazard exists.
- ▶ Do not operate the product with radio or digital cellular phone devices near to medical equipment.
- ▶ Do not operate the product with radio or digital cellular phone devices in aircraft.

1.8

FCC Statement, Applicable in U.S.



The greyed paragraph below is only applicable for products without radio.

⚠ WARNING

This equipment has been tested and found to comply with the limits for a Class B digital device, pursuant to part 15 of the FCC rules.

These limits are designed to provide reasonable protection against harmful interference in a residential installation.

This equipment generates, uses and can radiate radio frequency energy and, if not installed and used in accordance with the instructions, may cause harmful interference to radio communications. However, there is no guarantee that interference will not occur in a particular installation.

If this equipment does cause harmful interference to radio or television reception, which can be determined by turning the equipment off and on, the user is encouraged to try to correct the interference by one or more of the following measures:

- Reorient or relocate the receiving antenna.
- Increase the separation between the equipment and the receiver.
- Connect the equipment into an outlet on a circuit different from that to which the receiver is connected.
- Consult the dealer or an experienced radio/TV technician for help.

⚠ CAUTION

Changes or modifications not expressly approved by Leica Geosystems for compliance could void the user's authority to operate the equipment.

Labelling RTC360



0016140.001

Model: RTC360
 Art. No.: 838300
 Equip. No.: 1234567 S.No.: 2980001
 Power : 24V ~ 75W max. WLAN PW: 12345678
 Leica Geosystems AG
 CH-9435 Heerbrugg
 Manufactured: 01.2018
 Made in Switzerland



This device contains:
FCC ID: N6C-SXPCEAN2
IC: 4608A-SPECAN2
IP54
 Complies with IEC performance standards for laser products except for deviations pursuant to Laser Notice No. 50, dated June 24, 2007.
 This device complies with Part 15 of the FCC Rules. Operation is subject to the following two conditions: (1) this device may not cause harmful interference, and (2) this device must accept any interference received, including interference that may cause undesired operation.



Labelling GEB361



0016141.001



Type: GEB361
 Li-Ion Battery
 11.1 V ~ 5.6 Ah
 ~ 15 A / 62 Wh
 Leica Geosystems AG, CH-9435 Heerbrugg

Art.No.: 799191
 S.No.: XXXXX
 Made in China

This device complies with part 15 of the FCC Rules. Operation is subject to the following two conditions:
 (1) This device may not cause harmful interference, and
 (2) This device must accept any interference received, including interference that may cause undesired operation.



Labelling GKL341



0016142.001

Type 型号: GKL341
 Battery Charger 电池充电器 전기충전기
 Art.No.: 799187
 Input: 输入, 입력 인력: 100-240 V ~ / 50-60 Hz / 1.5 A max. / 175 VA
 24 V ~ 2.8 A max. ~ ~ ~
 Output: 输出, 输出力: 16.8 V ~ / 3 A max.
 Leica Geosystems AG
 CH-9435 Heerbrugg
 Manufacturer: 制造商, 제조사: RBC power solutions GmbH
 工厂, 工厂: 东莞捷成电子有限公司 EMI ASIA LTD
 Made in China, 中国, 中国制造

This device complies with part 15 of the FCC Rules. Operation is subject to the following two conditions:
 (1) This device may not cause harmful interference, and
 (2) This device must accept any interference received, including interference that may cause undesired operation.

Labelling GEV282



16773.001

Globaltek, Inc.
 108 Veterans Drive
 Northvale, NJ 07647
ITE POWER SUPPLY 电源供应器
 TYPE GEV 282
 P/N: 2824640
 Fuente de alimentación en el PUNTO DE ALIMENTACION de rete
 Adaptador de alimentación de red
 PART / Parte / PARTIE / 부품 / 部品 / 部品
 MODEL / Modelo / MODELLO / 型番 / 型番
 GT-4300AP / 15024-T3
 INPUT / Entrada / ENTRADA / 入力 / 入力 / 入力
 100 - 240V ~, 50 - 60 Hz, 2.0 A
 OUTPUT / Salida / SAIDA / 出力 / 出力 / 出力
 24V ~ 6.25A, 150W

Efficiency Level: V
 S/N: RoHSNNNNNNN1VVVYY
 Hecho en China / 中国製造 / MADE IN CHINA

 WARNING

This Class (B) digital apparatus complies with Canadian ICES-003.
Cet appareil numérique de la classe (B) est conforme à la norme NMB-003 du Canada.

Canada Compliance Statement

This device complies with Industry Canada's license-exempt RSSs. Operation is subject to the following two conditions:

1. This device may not cause interference; and
2. This device must accept any interference, including interference that may cause undesired operation of the device.

Canada Déclaration de Conformité

Le présent appareil est conforme aux CNR d'Industrie Canada applicables aux appareils radio exempts de licence. L'exploitation est autorisée aux deux conditions suivantes:

1. l'appareil ne doit pas produire de brouillage;
 2. l'appareil doit accepter tout brouillage radioélectrique subi, même si le brouillage est susceptible d'en compromettre le fonctionnement.
-

2

Description of the System

2.1

Packing / Unpacking the Instrument

Packing and unpacking

When in its transport container, the RTC360 can sit in either a face-up or face-down position.

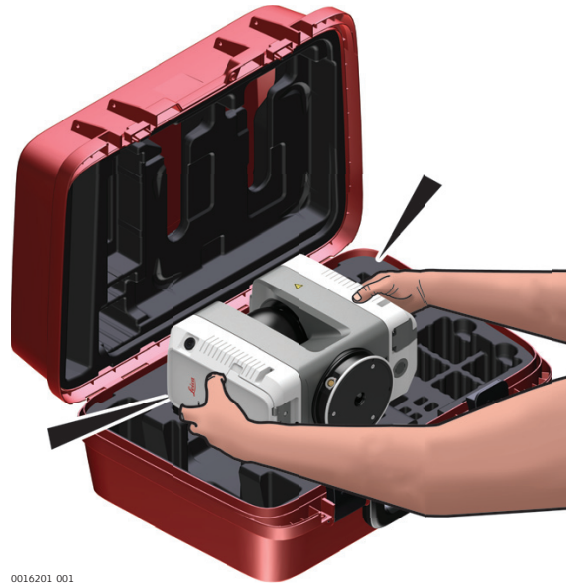

0016201_001

To take the instrument out of its container, grasp the instrument at the left and right side covers, and lift. Use caution due to the weight of the instrument (6 kg).

2.2

Container Contents

Container contents

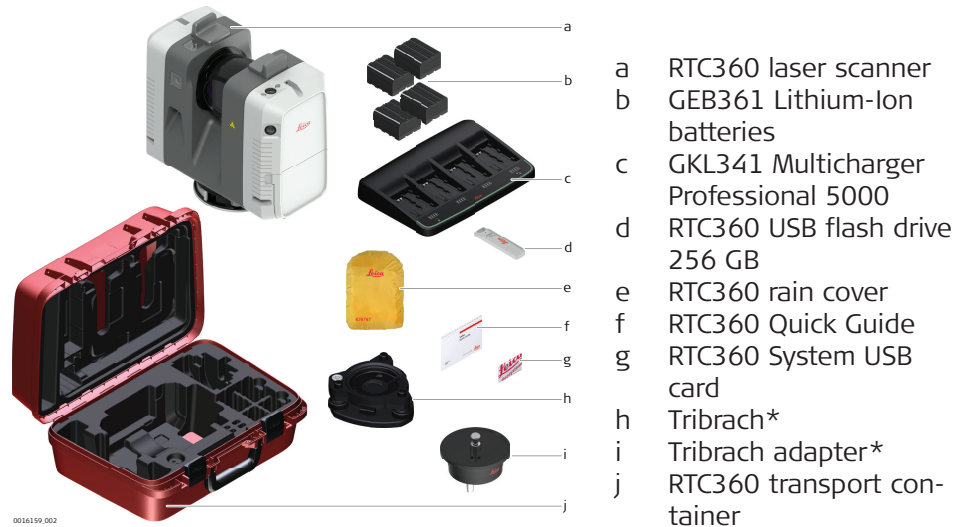

0016159_002

*optional

- a RTC360 laser scanner
- b GEB361 Lithium-Ion batteries
- c GKL341 Multicharger Professional 5000
- d RTC360 USB flash drive 256 GB
- e RTC360 rain cover
- f RTC360 Quick Guide
- g RTC360 System USB card
- h Tribrach*
- i Tribrach adapter*
- j RTC360 transport container

2.3

Backpack Contents

Backpack contents



0016153_001

- a RTC360 laser scanner
- b RTC360 backpack
- c GEB361 Lithium-Ion batteries
- d Lightweight tripod

2.4

Instrument Components

Instrument components

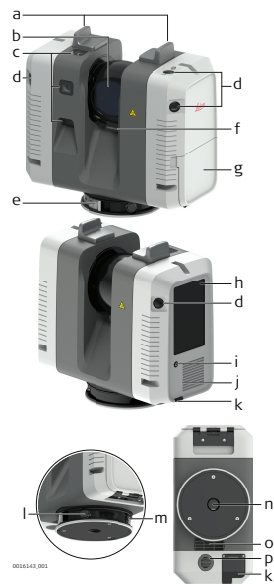

0016153_001

- a Antennas
- b Rotating mirror/laser aperture
- c HDR cameras
- d Cameras for visual inertial system
- e Quick release
- f Status LED
- g Battery compartment
- h Touch screen
- i On/Off button
- j Fan
- k USB slot
- l Socket for power supply, 5 pin female
- m Ethernet socket, 8 pin female
- n Quick release mount
- o Fan
- p Loudspeaker

2.5

System Components

System components

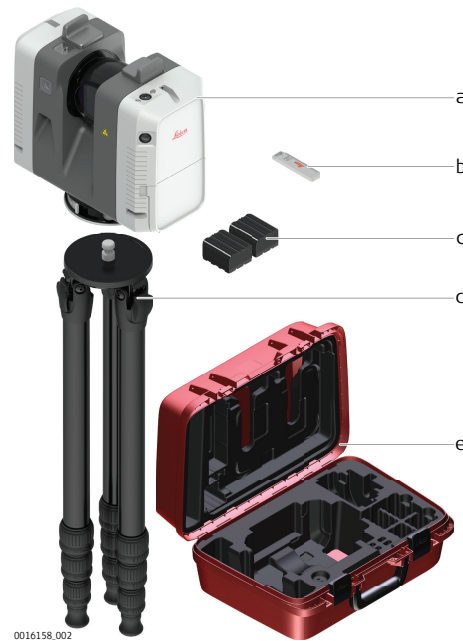

- a RTC360 laser scanner
- b RTC360 USB flash drive
- c GEB361 exchangeable batteries
- d Lightweight tripod
- e Transport container for RTC360 and accessories

2.6

System Concept

2.6.1

Power Concept

General

Use the batteries, chargers and accessories recommended by Leica Geosystems to ensure the correct operation of the instrument.

Power options

Model	Power supply
All instrument types	Internally by GEB361 battery, OR Externally by GEV282 AC power supply (for indoor use only).

2.6.2

Data Storage Concept

Description

Data is stored on an exchangeable USB data storage device.

Data storage device

The instrument comes with two Leica MS256 USB sticks (exFAT formatted) which fit into the USB port of the instrument.



Only use the Leica MS256 USB stick. Other devices are not compatible and may damage the instrument.



Unplugging connecting cables or removing the USB stick during the measurement can cause loss of data. Only remove the USB stick or unplug connecting cables when the **Eject USB stick** function has been executed.

Data transfer

The Leica MS256 USB stick is used to transfer data from the instrument to external computers.

All data recorded by the instrument and all meta data created by the field app on the remote tablet is stored on the USB stick.

Type	Description
Data	Scans, images, orientation
Meta data	Registration, tags, images

3 User Interface

3.1 Power Button

Power button

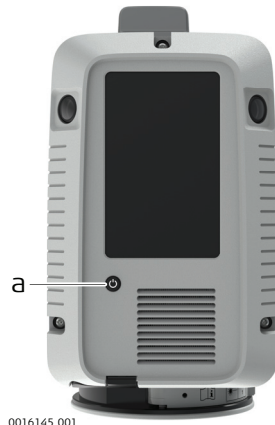

a Power button

Power button	when the RTC360 is	THEN
Press and hold the button 1 sec.	off.	The RTC360 switches on and the Power button starts blinking yellow.
Press and hold the button 1 sec.	on and ready.	The Power button starts blinking yellow and the RTC360 switches off.
Press and hold the button 10 sec.	on.	The RTC360 switches off immediately. Hard shut-down.









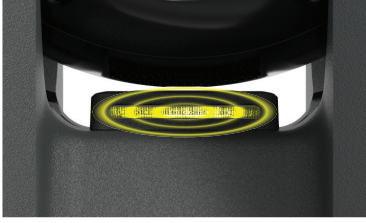

3.2 Device Status

Device status

The power button and the status LED light up green, yellow or red to show the operation states of the RTC360.

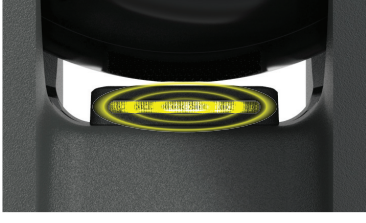
Component	Status
Power button	lights up continuous.
	is blinking.
Status LED	lights up continuous.
	is blinking.

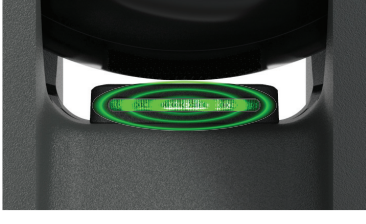
Operation mode

Power button	Status LED	Instrument status
		<p>The RTC360 is off.</p>
		<p>The RTC360 is booting up or shutting down.</p>
		<p>The RTC360 is ready.</p>
		<p>The RTC360 is recording.</p>
		<p>The RTC360 is being moved and the visual inertial system is recording.</p>
		<p>An unrecoverable system error occurred. Follow the instructions in the display. If necessary, shut down the instrument and reboot again. If status does not change, contact the Leica support.</p>

Screen overview



- a Status field
- b Job field
- c Acquisition time
- d Start button
- e Scan settings
- f Setup field



4 Operation

4.1 Instrument Setup

4.1.1 General Information

Use the tripod

The instrument should always be set up on its tripod. Using the tripod specified for the scanning system guarantees maximum stability during scanning operations.



-  Always set up the instrument on its tripod. Do not set up the instrument directly on the ground for scanning operations.
-  It is always recommended to shield the instrument from direct sunlight and avoid uneven temperatures around the instrument.

4.1.2 Lightweight Tripod Setup

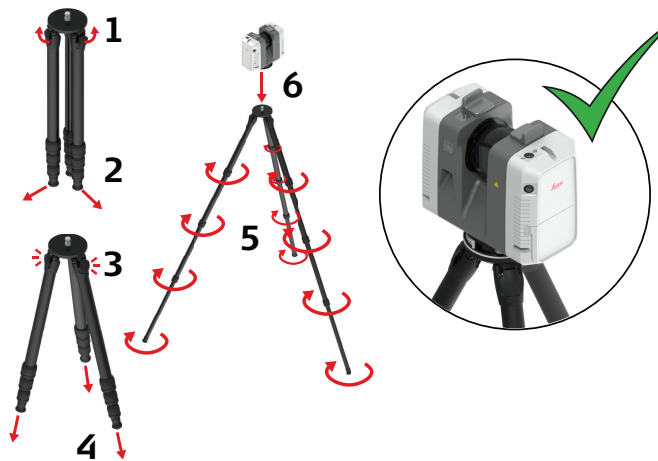
Instrument setup step-by-step



0016152_001

1. Unlock the locks at the top of the legs.
 2. Unfold the legs so that the locks lock in their maximum position.
 3. Move the legs back to a fixed position so that the locks click into place.
 4. Extend the tripod legs to allow for a comfortable working posture.
 5. Tighten all locking screws at the tripod legs.
-  Remove the rubber caps at the bottom of the tripod legs to uncover spikes for usage on a soft ground.
 -  Do not use the spikes on slippery ground.
6. Place the instrument on the quick release mount and secure it.

4.1.3

Heavy Duty Tripod Setup

Instrument setup step-by-step

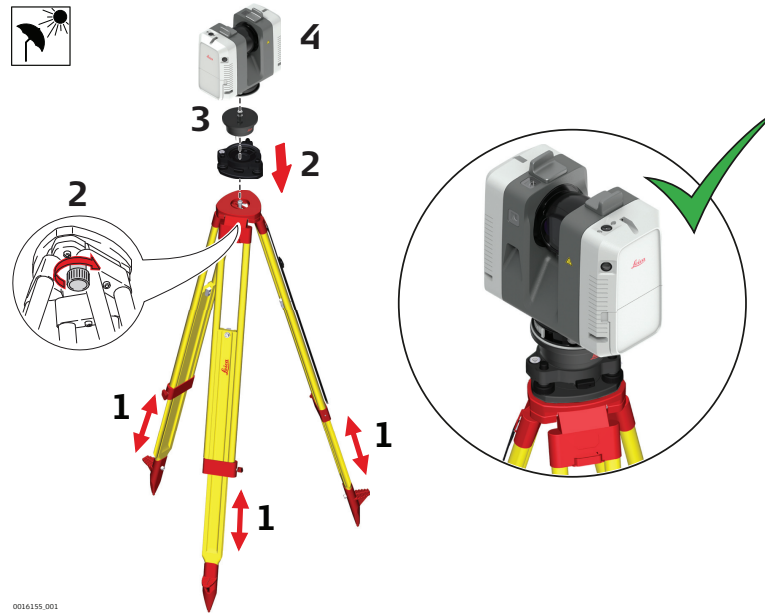

Shield the instrument from direct sunlight and avoid uneven temperatures around the instrument.

1. Extend the tripod legs to allow for a comfortable working posture. Ensure that the tripod plate is roughly horizontal.
2. Place the tribrach on the tripod and secure it with the central fixing screw.
3. Place the tribrach adapter on the tribrach and secure it with the locking knob of the tribrach.
4. Place the instrument on the quick release mount and secure it.

4.2

Power Supply



For details regarding the charging station refer to GKL341 User Manual.

4.2.1

Batteries

First-time use/ charging batteries

- The batteries must be charged before using them for the first time because they are delivered with an energy content as low as possible.
- The permissible temperature range for charging is from 0 °C to +40 °C / +32 °F to +104 °F. For optimal charging, we recommend charging the batteries at a low ambient temperature of +10 °C to +20 °C / +50 °F to +68 °F if possible.
- It is normal for the battery to become warm during charging. Using the chargers recommended by Leica Geosystems, it is not possible to charge the battery once the temperature is too high.
- For new batteries or batteries that have been stored for a long time (> three months), it is effectual to make only one charge/discharge cycle.
- For Li-Ion batteries, a single discharging and charging cycle is sufficient. We recommend carrying out the process when the battery capacity indicated on the charger or on a Leica Geosystems product deviates significantly from the actual battery capacity available.

Operation/ discharging

- The batteries can be operated from $-20\text{ }^{\circ}\text{C}$ to $+55\text{ }^{\circ}\text{C}$ / $-4\text{ }^{\circ}\text{F}$ to $+131\text{ }^{\circ}\text{F}$.
- Low operating temperatures reduce the capacity that can be drawn; high operating temperatures reduce the service life of the battery.

4.2.2

Exchanging the Batteries

NOTICE

The batteries are hot-swappable. Data acquisition requires two batteries inserted into the battery compartment. The instrument does not shut down when only one battery is inserted.

Insert and remove the exchangeable batter- ies

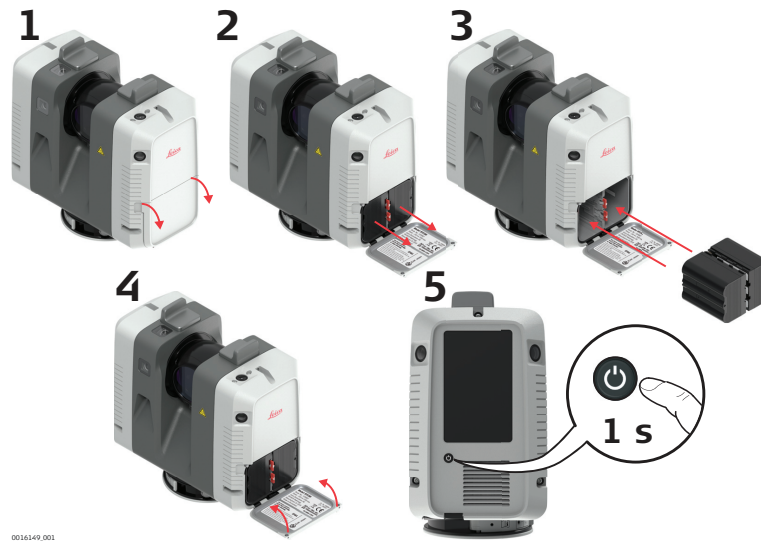

1. Open the battery compartment.
2. Remove the left battery from the battery compartment by pushing the upper red button to the right.
Remove the right battery from the battery compartment by pushing the lower red button to the left.
3. Insert the new batteries into the battery compartment.
 Ensure that the battery contacts are facing inwards.
4. Close the battery compartment.
5. Turn on the RTC360 to start the boot process.

4.3

Operation - Getting Started

Stand-alone operation step-by-step



0016235.001

1. Press the power button to turn on the RTC360.
 2. The RTC360 is starting. The power button and the status LED are blinking yellow.
 3. When the user interface is visible, the RTC360 is ready for operation. The power button and the status LED are now continuously green.
-  Do not touch or move the RTC360 while the system is recording.

Operation with hand-held device connection step-by-step

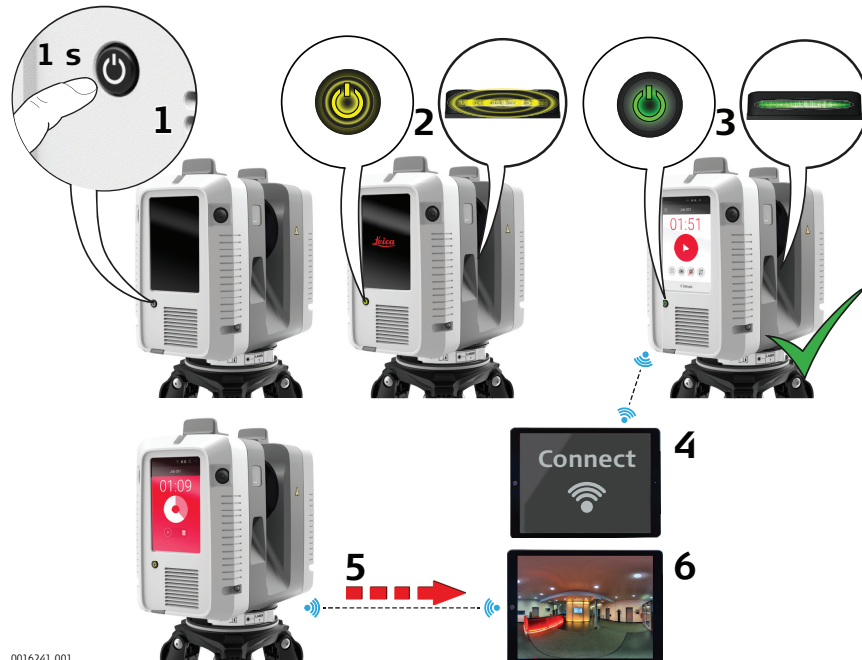



0016241.001

1. Press the power button to turn on the RTC360.
2. The RTC360 is starting. The power button and the status LED are blinking yellow.
3. When the user interface is visible, the RTC360 is ready for operation. The power button and the status LED are now continuously green.
4. Connect the handheld device with the RTC360.

5. Start the recording and simultaneous data transfer with the handheld device.
6. Start the processing of data on the handheld device.

Connecting to a handheld device step-by-step

1. Start the RTC360 and wait until the user interface is visible.
2. On the handheld device select **Settings** and tap **Wi-Fi**.
3. Select the network **RTC360-298xxxx** in the **Wi-Fi** settings to be connected.
 -  The number **xxxx** is the serial number of the RTC360.
4. Enter the password.
 -  The instrument specific password is printed on the type label in the battery compartment, for example "test1111".

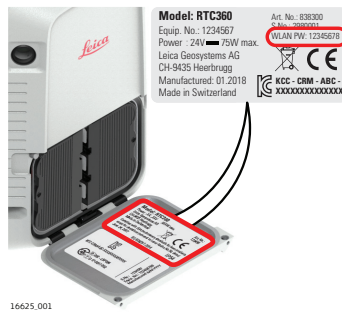

5. Start the app and connect the instrument.
 -  For further information, refer to the help menu in the app.

4.4

Imaging

Description

The RTC360 has two different types of image sensors:

- Three calibrated cameras for HDR, 360° spherical image acquisition.
- Five calibrated cameras for the visual inertial system VIS.

Imaging



a 3 cameras for HDR imaging

b 5 cameras for visual inertial system VIS

4.5

Scanning

4.5.1

Ambient Conditions

Unfavourable surfaces for scanning

- Highly reflective (polished metal, gloss paint)
- Highly absorbent (black)
- Translucent (clear glass)



Colour, powder or tape these surfaces before scanning if necessary.

Unfavourable weather conditions for scanning

- Rain, snow or fog may adversely affect measurement quality. Always use care when scanning in these conditions.
- Surfaces that are directly illuminated by the sun cause an increased range noise and therefore a larger measurement uncertainty.
- If some objects are scanned against the sunlight or a bright spotlight, the optical receiver of the instrument can be dazzled so heavily that in this area no measured data is recorded.

Temperature changes during scanning

If the instrument is brought from a cold environment, for example from storage, into a warm and humid environment, the mirror or in extreme cases even the interior optics can condense. This may cause measurement errors.



Precaution: Avoid rapid temperature changes and give the instrument time to acclimatise.

Dirt on the mirror

Dirt on the mirror such as a layer of dust, condensation or fingerprints may cause considerable measuring errors.

4.5.2

Onboard Controls















About the Start screen



The Start screen is displayed after the system boot process. Once it is visible the instrument is ready for scanning.

Element	Description
Status field	 WiFi enabled.
	 Internal battery status



Element	Description
	USB storage device status
	Do not remove USB storage device.
	Clicking the Settings icon opens the Settings screen.
Job field	
	Clicking the Job icon opens the list of all stored jobs.
	Name of the current scan job.
Time	
	Display of the acquisition time depending on the scan settings.
Start	
	Clicking the Start button starts the scan and image acquisition as defined in the scan settings.
Scan settings	
	Low scan resolution: 12 mm@10 m, maximum range 130 m
	Medium scan resolution: 6 mm@10 m, maximum range 130 m
	High scan resolution: 3 mm@10 m, maximum range 65 m
	HDR image acquisition enabled.
	HDR image acquisition disabled.
	Double Scan enabled.
	Double Scan disabled.
	Visual inertial system VIS enabled.

Element	Description
	Visual inertial system VIS disabled.
Setup field	7 Setups Number of setups in current job. Click the Setup field to open the setup list with thumbnails for each setup.

4.5.3

Troubleshooting

Basic troubleshooting

Problem	Possible Cause(s)	Suggested Remedies
Missing points in scan.	Dust, debris or fingerprints on rotating mirror.	Use glass cleaning tissue to clean the specific areas.

Advanced troubleshooting

Problem	Possible Cause	Suggested Remedies
When switching on the instrument or starting a scan, the system switches off automatically.	Capacity of battery is too low.	Recharge or change battery.
When switching on the instrument or starting a scan, the system switches off automatically even though it was totally recharged.	Battery charger is defective. Exchangeable battery is no longer charging.	Check the function of the battery charger. Please note the charging status displayed on the battery charger. At the end of its life time the exchangeable battery has lost most of its capacity. The battery needs to be replaced.

Troubleshooting - support contacts

If you experience problems with your instrument:

- Email the scanner's log files to your local support:
 - For **America**: us-support@hds.leica-geosystems.com
 - For **South America**: suporte@leica-geosystems.com.br
 - For **Europe, Middle East and Africa**: euro-support@hds.leica-geosystems.com
 - For **Asia**: asia-support@hds.leica-geosystems.com
- Log files can be transferred to the USB stick via the **Copy Log Files** command in the Settings menu.

4.5.4

Field of View (FoV)

Scanning laser - field of view

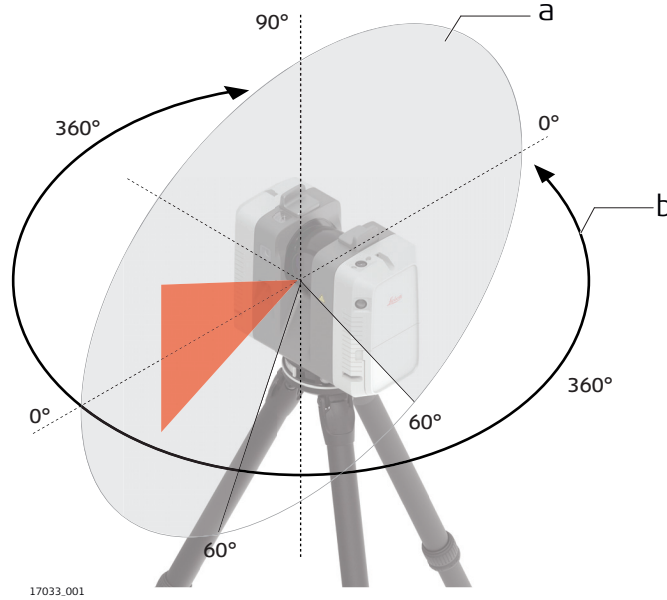

- a Vertical field of view: 300°
- b Horizontal field of view: 360°

4.6

Data Transfer

Description

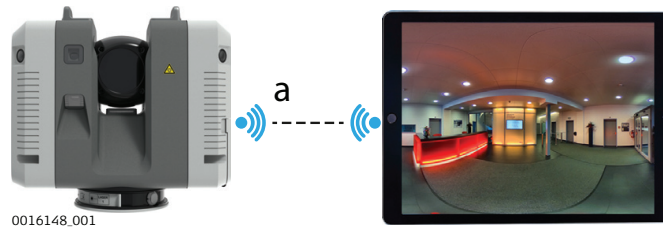

- a Preview data transfer from RTC360 to computing device. Refer to 4.3 Operation - Getting Started.

4.7

Working with the USB Data Storage Device



- Keep the USB stick dry.
- Use it only within the specified temperature range.
- Do not bend the USB stick.
- Protect the USB stick from direct impacts.

Insert and remove the USB stick step-by-step



Only remove the USB storage device after it has been checked out from the system using the Eject functionality in the Settings menu.



Failure to follow these instructions could result in data loss and/or permanent damage to the USB stick.

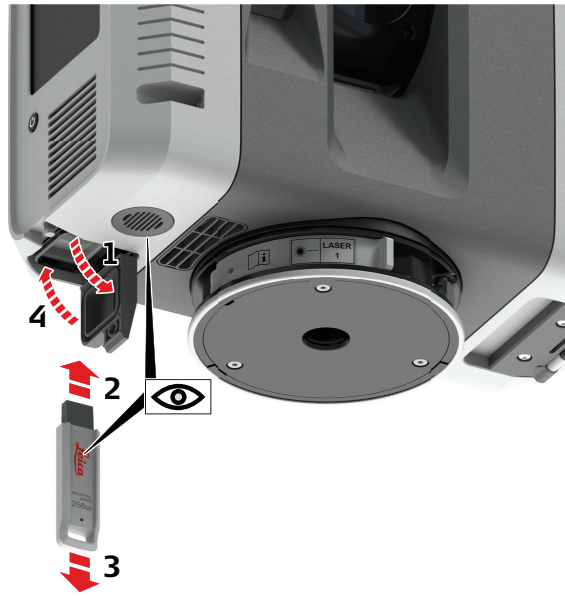

16468.002

1. Open the USB compartment at the bottom of the instrument.

 2. To insert the MS256 USB stick, hold the stick with the Leica logo facing to the right.
Slide it into the USB port until it clicks into position.

 -  Do not force the USB stick into the port.

 3. To remove the MS256 USB stick, slide the stick out of the USB port.

 4. Close the USB compartment.
-

5 Care and Transport

5.1 Transport

Transport in the field	<p>When transporting the equipment in the field, always make sure that you:</p> <ul style="list-style-type: none">• either carry the product in its original container,• or in the backpack,• or carry the tripod with its legs splayed across your shoulder, keeping the attached product upright.
Transport in a road vehicle	<p>Never carry the product loose in a road vehicle, as it can be affected by shock and vibration. Always carry the product in its container and secure it.</p> <p>For products for which no container is available use the original packaging or its equivalent.</p>
Shipping	<p>When transporting the product by rail, air or sea, always use the complete original Leica Geosystems packaging, container and cardboard box, or its equivalent, to protect against shock and vibration.</p>
Shipping, transport of batteries	<p>When transporting or shipping batteries, the person responsible for the product must ensure that the applicable national and international rules and regulations are observed. Before transportation or shipping, contact your local passenger or freight transport company.</p>

5.2 Field Check



For units that are exposed to high mechanical forces, for example through frequent transport or rough handling or for units stored for a long period, it is recommended to carry out test measurements periodically.

5.3 Storage

Product	<p>Respect the temperature limits when storing the equipment, particularly in summer if the equipment is inside a vehicle. Refer to "6 Technical Data" for information about temperature limits.</p> <ul style="list-style-type: none">• Refer to "Environmental Specifications" for information about storage temperature range.• Remove batteries from the product and the charger before storing.• After storage recharge batteries before using.• Protect batteries from damp and wetness. Wet or damp batteries must be dried before storing or use.• A storage temperature range of 0°C to +30°C/+32°F to 86°F in a dry environment is recommended to minimise self-discharging of the battery.• At the recommended storage temperature range, batteries containing a 40% to 50% charge can be stored for up to one year. After this storage period the batteries must be recharged.
----------------	---

5.4

Cleaning and Drying

Housing parts of product and accessories

- Never touch the glass and scanning mirror with your fingers.
- Use only a clean, soft, lint-free cloth for cleaning. If necessary, moisten the cloth with water or pure alcohol. Do not use other liquids; these may attack the polymer components.

Damp products

Dry the product, the backpack, the transport container, the foam inserts and the accessories at a temperature not higher than 40 °C /104 °F and clean them. Open the battery cover and dry the battery compartment. Do not repack until everything is completely dry. Always close the container or backpack when using in the field.

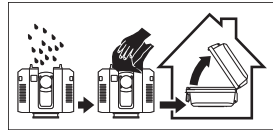

Charger and AC/DC power supply

Use only a clean, soft, lint-free cloth for cleaning.

Cables and plugs

Keep plugs clean and dry. Blow away any dirt lodged in the plugs of the connecting cables.

5.5

Glass Cleaning Procedure

General cleaning information

The scanning window must be kept clean. The instructions must be followed as described in this chapter to clean the scanner window.

CAUTION

Before any cleaning procedure, ensure that the instrument is switched off and the battery has been removed.

Dust and debris on optical surfaces

Using only a compressed gas duster to remove dust and debris from surface of scanner window.



Never rub off dust or debris as this will scratch the glass and so possibly cause permanent damage to the special optical coatings.

Cleaning of optical surfaces

Soiling of the glass pane can cause extreme measurement errors and therefore useless data!



All soiling that is visible on the glass pane has to be removed, except for single small dust particles that adhere inevitably.

For the glass cleaning procedure, the Leica cleaning tissue provided with the system is recommended.

Clean the glass pane regularly with the recommended cleaning tissue:

- Switch off instrument and remove the battery.
 - Washing hands is necessary in order to avoid grease on the cleaning tissue.
 - Better, use gloves to avoid finger oil on the glass.
 - Then use the Leica cleaning tissue.
 - If any smears from cleaning are visible against back light, repeat the procedure.
 - Do not use air from the pneumatic power system as this is always slightly oily!
-

6 Technical Data

6.1 General Technical Data of the Product



For details regarding the charging station refer to GKL341 User Manual.

Storage and communication

Function	Component
Internal storage	Removable 256 GB USB 3.0 memory device. 235 GB effective, exFAT formatted.
Communication	Integrated 802.11 a/b/g/n WLAN.

Internal HDR cameras

The RTC360 has three integrated HDR digital cameras.

Camera data	Value
Type	Colour sensor, fixed focal length
Single image	4000 x 3000 pixels, 62° x 48° (V x Hz)
Full dome	36 images, automatically spatially rectified, 432 Mpx raw data, 360° x 300° 100 Mpx on point cloud with 3 mm resolution
White balancing	Automatic
HDR	Automatic, 5 brackets
Minimum range	0.5 m

Additional internal sensors

The RTC360 is a multi-sensor system equipped with various integrated sensors to allow for automated online registration in the field.

Sensor	Description
Visual inertial system VIS	Video enhanced inertial measuring system to track movement of the scanner position relative to the previous setup in real-time.
Tilt	IMU-based. Accuracy: 3' for any tilt.
Altimeter	Electronic barometer to detect the difference in elevation relative to a reference elevation.
Compass	Electronic compass to deliver the orientation of the instrument.
GNSS	Onboard GNSS receiver to calculate the position of the instrument.

6.2 System Performance

System performance and accuracy



All accuracy specifications are on a level of confidence of 68% according to the Guide of the Expression of Uncertainty in Measurement (JCGM100:2008).

Angle accuracy of single measurement

Accuracy (horizontal/vertical)
18"/18"

3D point accuracy of single measurement

Albedo	Distance [m]				
	5	10	20	40	60
White 89%	1.4 mm	1.9 mm	2.9 mm	5.3 mm	7.8 mm
Grey 21%	1.5 mm	2.0 mm	3.2 mm	5.7 mm	8.2 mm
Black 8%	1.6 mm	2.2 mm	3.4 mm	6.1 mm	8.8 mm

6.3

Laser System Performance

Laser scanning system data



The scanning system is a high speed time-of-flight unit, enhanced by Waveform Digitising (WFD) technology with a maximum scan rate of 2.000.000 points/second.

Laser unit:

Scanning laser	Value
Classification	Laser Class 1 (in accordance with IEC 60825-1 (2014-05))
Wavelength	1550 nm (invisible)

Range:

Scanning data	Value
Beam divergence	0.5 mrad (1/e2, full angle)
Beam diameter at front window	6 mm (1/e2)
Minimum range	0.3 m
Maximum range	130 m @ 89% albedo
Range accuracy	1.0 mm +10 ppm from 0.5 m to 130 m

Range noise of single measurement:

Albedo	Distance [m]				
	5	10	20	40	60
White 89%	0.3 mm	0.4 mm	0.5 mm	0.6 mm	1.0 mm
Grey 21%	0.4 mm	0.5 mm	0.6 mm	0.8 mm	2.0 mm
Black 8%	0.5 mm	0.6 mm	0.7 mm	2.5 mm	5.0 mm

Field-of-View (per scan):

Field-of-View	Value
Selection	Always full dome.
Horizontal	360°
Vertical	300°
Scanning optics	Vertically rotating mirror on horizontally rotating base.

Maximum range for 3 settings:

Point density mode	Resolution [mm @ 10m]	Maximum range [m]
Low	12	130
Medium	6	130
High density	3	65

Scan duration for 3 settings:

Point density mode	Resolution [mm @ 10m]	Estimated scan duration [MM:SS] for a full dome scan
Low	12	00:25
Medium	6	00:50
High density	3	01:40

Image capturing time:

Camera type	Estimated image duration [MM:SS]
HDR	01:00

Scan size for 3 settings:

Resolution [mm @ 10m]	Approx. scan size [Points Hz x V]	Scan without colour [MB]	Scan with colour [MB]
Low	2083 x 5084	~183	~1678
Medium	4166 x 10168	~732	~2228
High density	8333 x 20334	~2913	~4396

6.4**Electrical Data****RTC360 power supply and consumption****Power supply:****Exchangeable battery**

11.1V DC; Two exchangeable GEB361 batteries needed for operation.

Power consumption:**Instrument**

30 W typical; 75 W max.

GEB361 exchangeable battery

Supply	Value
Type	Li-Ion
Voltage	11.1 V
Capacity	5.6 Ah

Battery operating and charging times

Exchangeable battery	Value
Operating time	up to 60 setups per battery set, typical continuous use: <ul style="list-style-type: none"> • at room temperature, • with medium resolution and • with Imaging/VIS enabled.
Charging time	Typical charging time with charger GKL341 is 4-8 hours at room temperature. <ul style="list-style-type: none"> • 1-2 batteries: up to 4 h • 3-4 batteries: up to 8 h

GEV282 AC/DC power supply

Mode	Value
Input	100-240 V AC, 50-60 Hz, 2.0 A
Output	24 V DC, 6.25 A, 150 W

6.4.1

Pin Assignment of Lemo Ports

Ethernet port - for service purposes only

Lemo1, 8 pin female

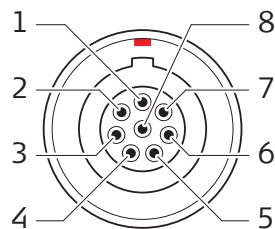

010743_001

Pin	Name
1	D1+
2	D1-
3	D2+
4	D2-
5	D3+
6	D3-
7	D4+
8	D4-

Power supply port

Lemo1, 5 pin female

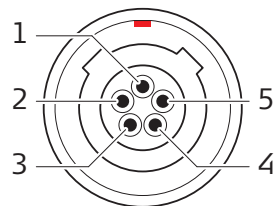

010744_001

Pin	Name	Function
1	PWR_IN	Power-In, 24 V
2	NC	Do not connect
3	GND	Ground
4	GND	Ground
5	PWR_IN	Power-In, 24 V

6.5 Environmental Specifications

6.5.1 RTC360

Environmental specifications RTC360

Temperature range:

Type	Operating temperature [°C]	Storage temperature [°C]
RTC360	-5 to +40	-40 to +70

Protection against water, dust and sand:

Type	Protection
RTC360	IP54 (IEC 60529), upright $\pm 15^\circ$ / upside down $\pm 15^\circ$ <ul style="list-style-type: none"> Dust protected Protection against splashing water from any direction IP51 (IEC60529), in any other position <ul style="list-style-type: none"> Dust protected Protection against dripping water

Humidity:

Type	Protection
RTC360	Max 95 % non condensing

Lighting:

Type	Conditions
RTC360	Fully operational from bright sunlight to complete darkness.

6.5.2 GEB361 Battery and GEV282 AC/DC Power Supply

Environmental specifications

Temperature range

Temperature	GEB361 battery	GEV282 AC/DC power supply
Operating Temperature	Charging: 0 °C to +45 °C Discharging: -20 °C to +60 °C	0 °C to 40 °C
Storage Temperature	-40 °C to +70 °C	-10 °C to 80 °C

Protection against water, dust, sand and humidity

Type	Protection
GEB361 battery	IP54 (IEC 60529) Dust protected Protection against splashing water from any direction. Humidity max. 95% non condensing.
GEV282 AC/DC power supply	Only operate in dry environments, for example in buildings and vehicles.

6.6

Dimensions

Dimensions

Part	Dimensions [mm] (D x W x H)	Dimensions ["] (D x W x H)
RTC360 laser scanner	120 x 240 x 230	4.7 x 9.4 x 9.1
GEV282 AC/DC power supply	2.5 x 72.2 x 42.0	0.1 x 2.8 x 1.7
GEB361 battery	60 x 72 x 31	2.4 x 2.8 x 1.2
GVP730 transport container	257 x 537 x 383	10.1 x 21.1 x 15.1
GVP736 backpack	200 x 350 x 460	7.9 x 13.8 x 18.1

Part	Dimensions [mm] (Diameter)	Dimensions ["] (Diameter)
GAD120 tribrach adapter	104.5 x 81.2	4.1 x 3.2
GAD121 adapter plate for flexible mounting	145 x 35	5.7 x 1.4
GAD122 adapter to mount a RTC360 on top of a Leica tripod	104.5 x 40	4.1 x 1.6

RTC360 laser scanner:

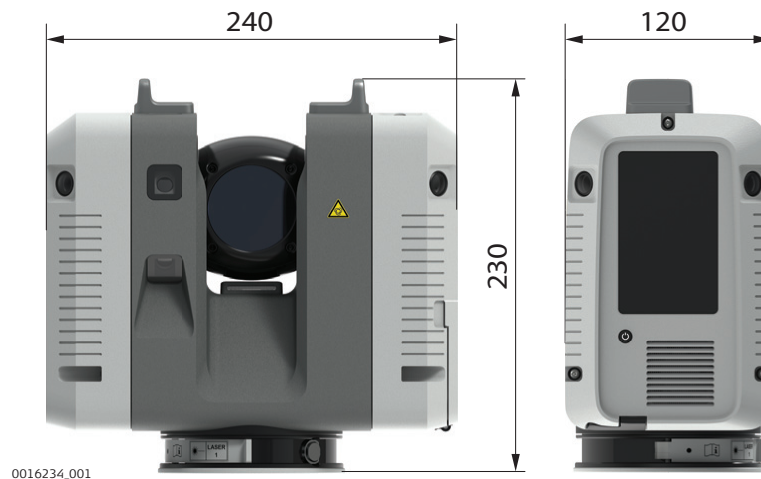

GAD120 tribrach adapter:



GAD121 adapter plate for flexible mounting:

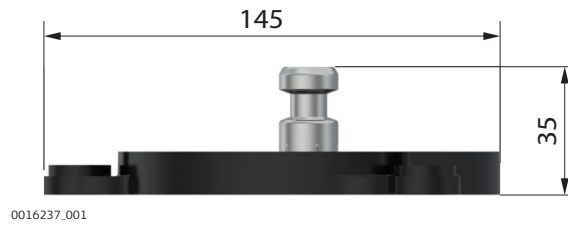

GAD122 adapter to mount a RTC360 on top of a Leica tripod:

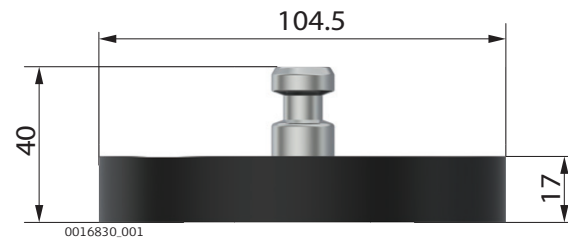

6.7

Weight

Weight

Part	Weight [kg]	Weight [lbs]
RTC360 laser scanner	5.3 nominal	11.7 nominal
GEV282 AC/DC power supply	0.86	1.9
GEB361 battery	0.34	0.7
RTC360 transport container (without scanner and accessories)	3.67	8.1
GVP736 backpack	1.79	3.9

Part	Weight [kg]	Weight [lbs]
GAD120 tribrach adapter	0.43	0.9
GAD121 adapter plate for flexible mounting	0.85	1.9

6.8

Accessories

Scope of delivery

Included standard accessories:

- RTC360 transport container
- GEV282 AC/DC power supply
- GKL341, Multicharger Professional 5000
- Battery GEB361, 4x
- RTC360 USB Flash Drive - 256 GB, 2x
- RTC360 Rain cover
- RTC360 Quick guide
- RTC360 System USB card
- Cleaning tissue
- 12 month warranty
- Calibration certificate digital access via online registration

Additional accessories

- Additional batteries GEB361
- RTC360 lightweight tripod GST80
- RTC360 tribrach adapter GAD120
- RTC360 adapter plate for flexible mounting GAD121
- Adapter to mount a RTC360 on top of a Leica tripod GAD122
- RTC360 backpack GVP730
- Range of Customer Care Products (CCP) that include support and hardware.

6.9

Conformity to National Regulations

6.9.1

RTC360

Conformity to national regulations

- FCC Part 15 (applicable in US)
- Hereby, Leica Geosystems AG declares that the radio equipment type RTC360 is in compliance with Directive 2014/53/EU and other applicable European Directives.
The full text of the EU declaration of conformity is available at the following Internet address: <http://www.leica-geosystems.com/ce>.
- 
 Class 1 equipment according to European Directive 2014/53/EU (RED) can be placed on the market and be put into service without restrictions in any EEA member state.
- The conformity for countries with other national regulations not covered by the FCC part 15 or European Directive 2014/53/EU has to be approved prior to use and operation.
- Japanese Radio Law.
 - This device is granted pursuant to the Japanese Radio Law (電波法).
 - This device should not be modified (otherwise the granted designation number will become invalid).

Frequency band	Type		Frequency band [MHz]
	WLAN		

Output power	Type		Output power [mW]
	WLAN		

Antenna	Type	Antenna	Gain [dBi]
	WLAN		Integrated antennas, 2x2 MIMO

6.9.2 Dangerous Goods Regulations

Dangerous Goods Regulations

Many products of Leica Geosystems are powered by Lithium batteries.

Lithium batteries can be dangerous under certain conditions and can pose a safety hazard. In certain conditions, Lithium batteries can overheat and ignite.



When carrying or shipping your Leica product with Lithium batteries onboard a commercial aircraft, you must do so in accordance with the **IATA Dangerous Goods Regulations**.



Leica Geosystems has developed **Guidelines** on "How to carry Leica products" and "How to ship Leica products" with Lithium batteries. Before any transportation of a Leica product, we ask you to consult these guidelines on our web page (<http://www.leica-geosystems.com/dgr>) to ensure that you are in accordance with the IATA Dangerous Goods Regulations and that the Leica products can be transported correctly.



Damaged or defective batteries are prohibited from being carried or transported onboard any aircraft. Therefore, ensure that the condition of any battery is safe for transportation.

Software Licence Agreement

This product contains software that is preinstalled on the product, or that is supplied to you on a data carrier medium, or that can be downloaded by you online according to prior authorisation from Leica Geosystems. Such software is protected by copyright and other laws and its use is defined and regulated by the Leica Geosystems Software Licence Agreement, which covers aspects such as, but not limited to, Scope of the Licence, Warranty, Intellectual Property Rights, Limitation of Liability, Exclusion of other Assurances, Governing Law and Place of Jurisdiction. Please make sure, that at any time you fully comply with the terms and conditions of the Leica Geosystems Software Licence Agreement.

Such agreement is provided together with all products and can also be referred to and downloaded at the Leica Geosystems home page at <http://leica-geosystems.com/about-us/compliance-standards/legal-documents> or collected from your Leica Geosystems distributor.

You must not install or use the software unless you have read and accepted the terms and conditions of the Leica Geosystems Software Licence Agreement. Installation or use of the software or any part thereof, is deemed to be an acceptance of all the terms and conditions of such Licence Agreement. If you do not agree to all or some of the terms of such Licence Agreement, you must not download, install or use the software and you must return the unused software together with its accompanying documentation and the purchase receipt to the distributor from whom you purchased the product within ten (10) days of purchase to obtain a full refund of the purchase price.

Open source information

The software on the product may contain copyright-protected software that is licensed under various open source licences.

Copies of the corresponding licences:

- are provided together with the product (for example in the About panel of the software).
- can be downloaded on <http://opensource.leica-geosystems.com>.

If foreseen in the corresponding open source licence, you may obtain the corresponding source code and other related data on <http://opensource.leica-geosystems.com>. Contact opensource@leica-geosystems.com in case you need additional information.

870891-1.0.1en

Original text (870891-1.0.1en)

Printed in Switzerland

© 2018 Leica Geosystems AG, Heerbrugg, Switzerland

Leica Geosystems AG

Heinrich-Wild-Strasse
CH-9435 Heerbrugg
Switzerland
Phone +41 71 727 31 31

www.leica-geosystems.com



- when it has to be **right**

Leica
Geosystems